

# ZERO-X<sup>®</sup>

## ... RAPTURE<sup>HD</sup> ...



## DRONE USER MANUAL

PRODUCT CODE: ZX-RHD

[www.zero-x.com.au](http://www.zero-x.com.au) • [www.zero-x.co.nz](http://www.zero-x.co.nz)



<b>1</b>	<b>Welcome .....</b>	<b>5</b>
	Before you get up in the air .....	5
	General Safety .....	5
	Battery Safety .....	6
<b>2</b>	<b>Introduction.....</b>	<b>7</b>
	2.1 Package Contents .....	7
	Fig 2.1.1 .....	7
	2.2 Product Overview .....	8
	Rapture <sup>HD</sup> Drone.....	8
	Fig 2.2.1 .....	8
	Fig 2.2.2 .....	8
	Remote Control .....	8
	Fig 2.2.3 .....	8
	Remote Control LCD Screen .....	9
	Fig 2.2.4 .....	9
<b>3</b>	<b>Setting up you Zero-X Rapture<sup>HD</sup> .....</b>	<b>9</b>
	3.1 Charging the Battery.....	9
	3.2 Installing the Rapture <sup>HD</sup> Battery .....	10
	Fig 3.2.1 .....	10
	Fig 3.2.2 .....	10
	3.3 Camera Connection Guide .....	10
	Fig 3.3.1 .....	10
	3.4 Installing a Micro SD Card (Micro SD Card not included) .....	10
	Fig 3.4.1 .....	10
	3.5 Installing/Removing Rotor Guards.....	10-11
	Fig 3.5.1 .....	10
	3.6 Remote Control .....	11
	Fig 3.6.1 .....	11
	Fig 3.6.2 .....	11
<b>4</b>	<b>Flight Safety .....</b>	<b>11</b>
	4.1 Flying your Rapture <sup>HD</sup> .....	11-12
	Fig 4.1.1 .....	12
	4.2 Trouble Shooting .....	12
	4.3 Controlling your Rapture <sup>HD</sup> .....	13
	Basic Controls .....	13
	Fig 4.3.1 .....	13
	4.4 Speed Modes.....	13-14
	Low Speed.....	13
	Mid Speed.....	14
	High Speed .....	14
	4.5 Trimming .....	14
	Fig 4.5.1 .....	14

4.6 360° Flipping .....	15
4.7 Using you Camera.....	15
Shooting Video .....	15
Fig 4.7.1 .....	15
Shooting Photos.....	16
Fig 4.7.2 .....	16
4.8 First Person View Display.....	16
Interface .....	16
Fig 4.8.1 .....	16
Brightness .....	16
Fig 4.8.2 .....	16
Pairing .....	16
Directory Screen.....	17
Fig 4.8.3 .....	17
Viewing.....	17
Fig 4.8.4 .....	17
Deleting Videos And Photos .....	18
<b>5 Maintenance .....</b>	<b>18</b>
5.1 Cleaning .....	18
5.2 Rotor Blade Installation and Replacement Guide .....	18
Fig 5.1.1 .....	18
Fig 5.1.2 .....	18
Fig 5.1.3 .....	18
Fig 5.1.4 .....	18
5.3 Motor Replacement Guide.....	19
5.4 Rotor Blade Replacement.....	19-20
Fig 5.4.1 .....	19
Fig 5.4.2 .....	19
Fig 5.4.3 .....	19
Fig 5.4.4 .....	19
Fig 5.4.5 .....	19
Fig 5.4.6 .....	19
Fig 5.4.7 .....	19
Fig 5.4.8 .....	20
Fig 5.4.9 .....	20
<b>6 Parts And Accessories .....</b>	<b>20</b>
<b>7 Specifications .....</b>	<b>20</b>
<b>8 Warranty.....</b>	<b>21</b>

## 1. WELCOME

Thanks for purchasing a Zero-X Rapture<sup>HD</sup>, get ready to have the time of your life! We're sure your Zero-X Rapture<sup>HD</sup> will bring you a world of great experiences in the air.

Please take the time to read the following safety warnings and operating instructions carefully.

### **BEFORE YOU GET UP IN THE AIR**

Connect the Rapture<sup>HD</sup> battery to the included USB charging cable and insert the USB charging cable into the supplied USB wall charger. While the battery is charging the LED on the charging cable will glow red. Once charging is complete the light will glow green. While the battery is charging take the time to read the instructions and familiarise yourself with the controls of your Zero-X Rapture<sup>HD</sup>.

### **GENERAL SAFETY**

Please familiarise yourself with your local legislation regarding drone usage before you begin using your Zero-X Rapture<sup>HD</sup>.

Included in the package contents of your Zero-X Rapture<sup>HD</sup> are the Australian CASA guidelines, please read carefully and understand this information as operating a drone outside of these guidelines may result in legal issues. Zero-X takes no responsibility for operation of this product outside of what is legally permissible in your local area.

- Do not fly your Rapture<sup>HD</sup> any closer than 30 metres from people, animals or buildings, and check to make sure you are no closer than 5.5 kilometres from any airfields or airports.

For more information on CASA's Australian legislation visit:

<http://www.casa.gov.au/> For information outside Australia please visit the website of your local aviation authority.

- Do not attempt to modify the Rapture<sup>HD</sup> or any of its components in any way, doing so will void your warranty and may affect the operation of the drone.
- Do not use the Rapture<sup>HD</sup> in any conditions that could affect, damage or impair your view of the Rapture<sup>HD</sup> including rain, wind, snow, fog or low light.
- Avoid getting your Rapture<sup>HD</sup> wet, dusty or sandy. These elements will damage the components of your Rapture<sup>HD</sup>.
- Please pay attention to the indication of low battery to avoid damage to your Rapture<sup>HD</sup>, or your surroundings.
- Please do not attempt to touch the Rapture<sup>HD</sup> when the Remote Control is powered on or if the rotor blades are turning.
- When flying your Rapture<sup>HD</sup>, please keep in mind the privacy of others.

## **IMPORTANT INFORMATION - PLEASE READ BEFORE USE**

### **BATTERY SAFETY**

When handled incorrectly, Lithium polymer batteries can be dangerous and can potentially harm and do damage to persons or property. Zero-X does not accept any liability of damage to persons or property if the battery is not correctly charged, stored or protected.

- Always unwind all cables before charging.
- Do not over charge the battery. Once the charging process is completed, remove the battery from the charger as soon as possible.
- You must charge the Lithium polymer battery in a safe area away from flammable materials.
- Only use the included, or replacement Zero-X Rapture<sup>HD</sup> compatible chargers and batteries.
- The battery is only to be charged under adult supervision, do not leave charging batteries unattended. You should always remain in constant observation to monitor the charging process and react immediately to any potential problems that may occur.
- Do not charge the battery in temperatures hotter than 40°C or colder than 0°C.
- Do not cover the batteries when charging. Do not leave batteries in direct sunlight.
- After each flight & or crash, please check battery for any damage or swelling.
- If the batteries are damaged, leaking, making noise, punctured or malformed in any way DO NOT attempt to use it. Please dispose of the battery immediately and safely in the correct manner.
- Do not bend, puncture, crush or scratch the drone's batteries. Do not store batteries in your pockets, on your person or in extreme temperatures.
- After flying/discharging the battery you must allow it to cool to ambient/ room temperature before recharging.
- If at any time during the charge or discharge process the battery begins to balloon or swell, discontinue charging or discharging immediately. Quickly and safely disconnect the battery, then place it in a safe, open area away from flammable materials to observe it for at least 15 minutes. Continuing to charge or discharge a battery that has begun to balloon or swell can result in a fire. A battery that has ballooned or swollen even a small amount must be removed from service completely.
- Never plug in a battery and leave it to charge unattended overnight.
- Non-compliance with the above warnings may result in the failure of the battery.

## 2. INTRODUCTION

### 2.1 PACKAGE CONTENTS

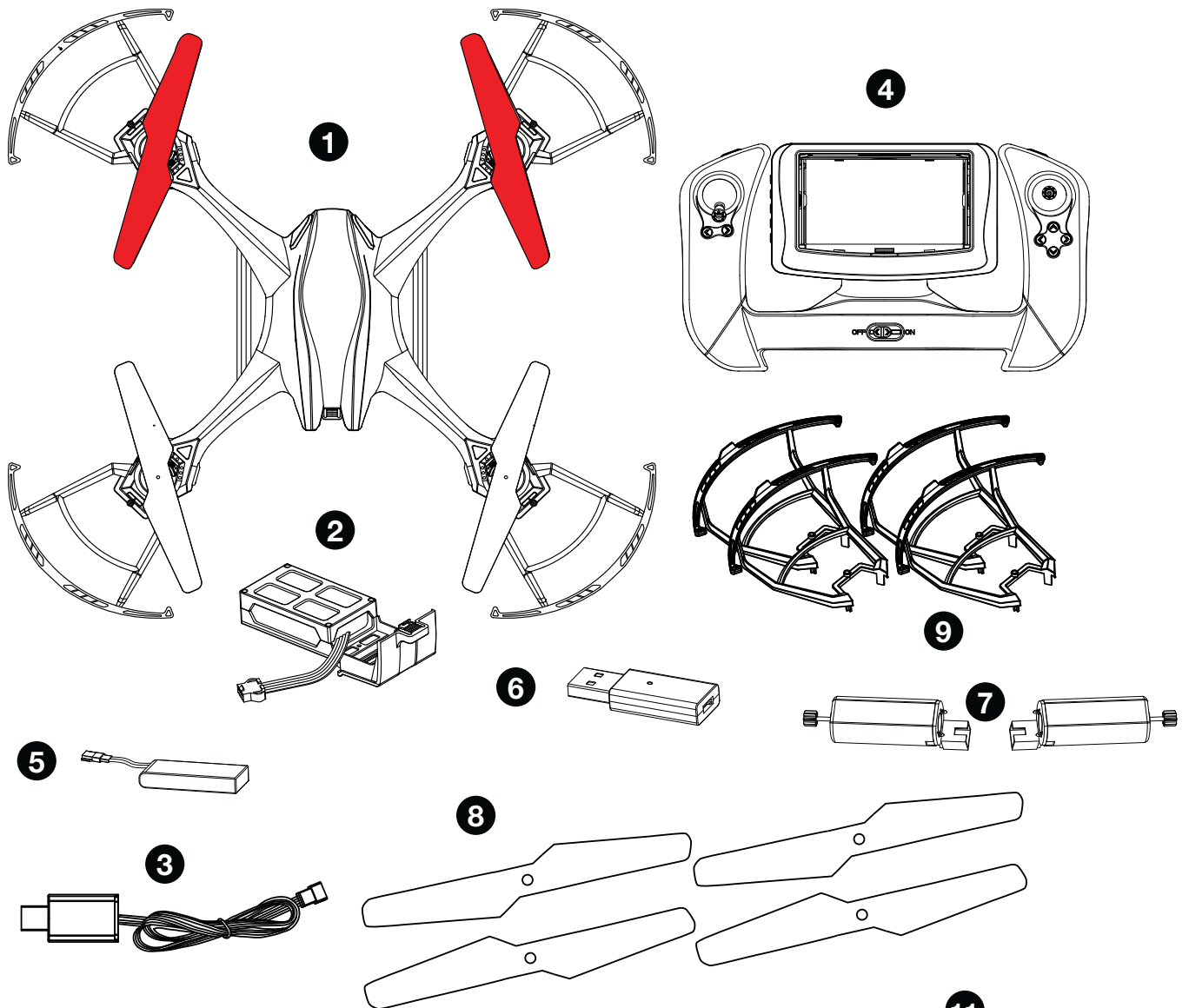

1.	Rapture <sup>HD</sup> Drone
2.	Rapture <sup>HD</sup> Battery
3.	Rapture <sup>HD</sup> Battery Charger
4.	Remote Control
5.	Remote Control Battery
6.	Remote Control Battery Charger
7.	Spare Motors
8.	Rotor Blades
9.	Rotor Guards
10.	Screwdriver
11.	User Guide
12.	USB Wall Charger

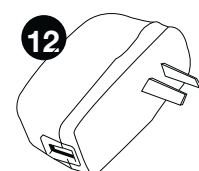
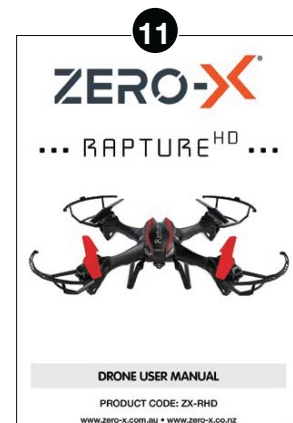

\*Fig 2.1.1

## 2.2 PRODUCT OVERVIEW RAPTURE<sup>HD</sup> DIAGRAM

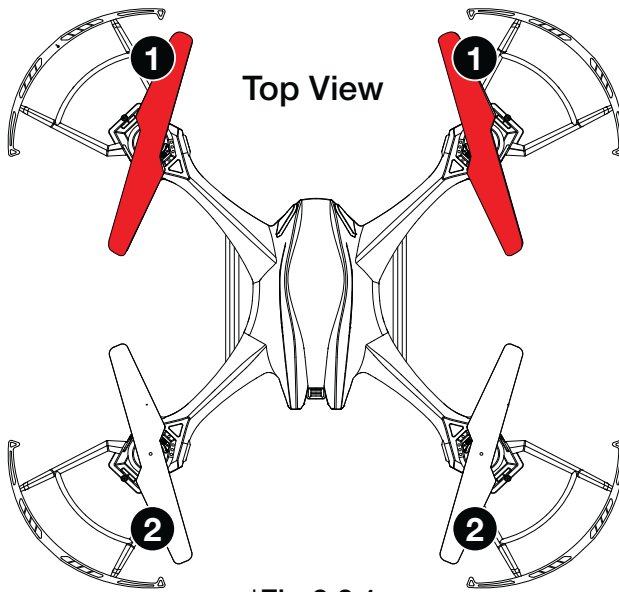

\*Fig 2.2.1

1.	Front Rotor Blades
2.	Rear Rotor Blades

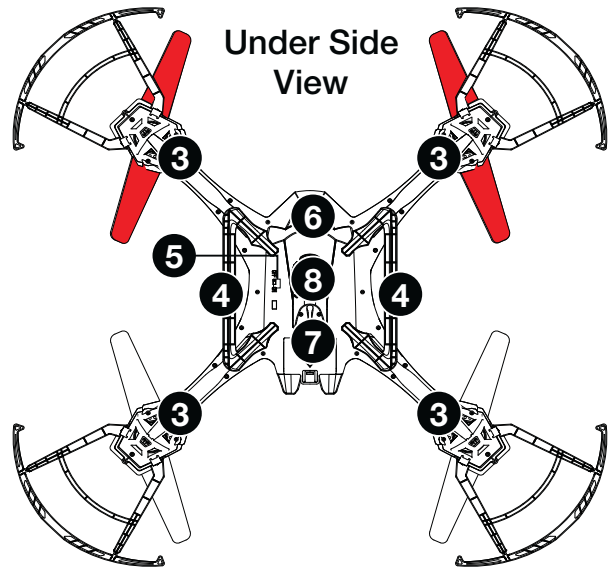

\*Fig 2.2.2

3.	LED Lights
4.	Feet
5.	Power Switch
6.	Camera
7.	Battery
8.	Micro SD Card Slot*

\* Micro SD Card not included

## REMOTE CONTROL DIAGRAM

1.	Power Switch
2.	Left Thumbstick (Acceleration/Yaw)
3.	Right Thumbstick (Pitch/Roll)
4.	Yaw Trim Controller
5.	Pitch / Roll Trim Controller
6.	FPV Screen
7.	View Button
8.	Record Button
9.	Photo Button
10.	Up Button
11.	Down Button
12.	Micro SD Card Slot*
13.	Glare Shield (Detachable)
14.	Speed Button
15.	Flip Mode (On/Off)

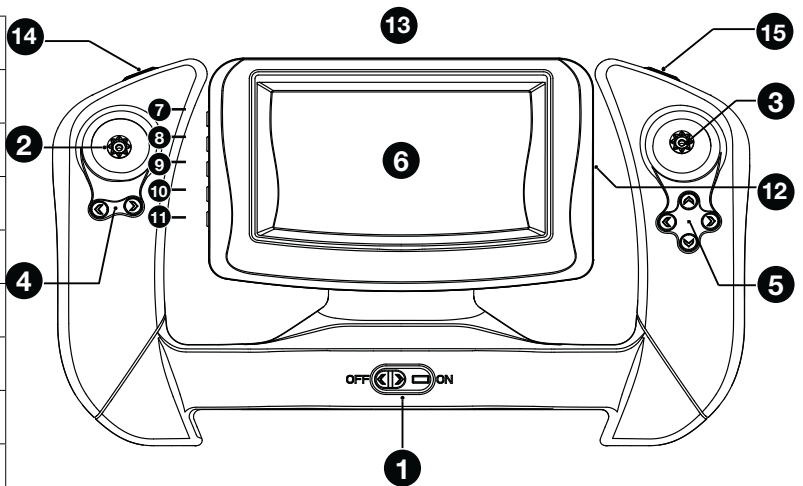

\*Fig 2.2.3

\* Micro SD Card not included



## REMOTE CONTROL LCD SCREEN DIAGRAM

1.	Connection
2.	View Footage / Photos (Micro SD card must be inserted into the FPV screen to view)
3.	Shoot Video Footage (Micro SD card must be inserted in the Rapture <sup>HD</sup> Drone to shoot video footage)
4.	Shoot Still Photo (Micro SD card must be inserted in the Rapture <sup>HD</sup> Drone to shoot still photos)
5.	Brightness Up
6.	Brightness Down
7.	Micro SD Card in camera icon
8.	Micro SD Card in FPV icon

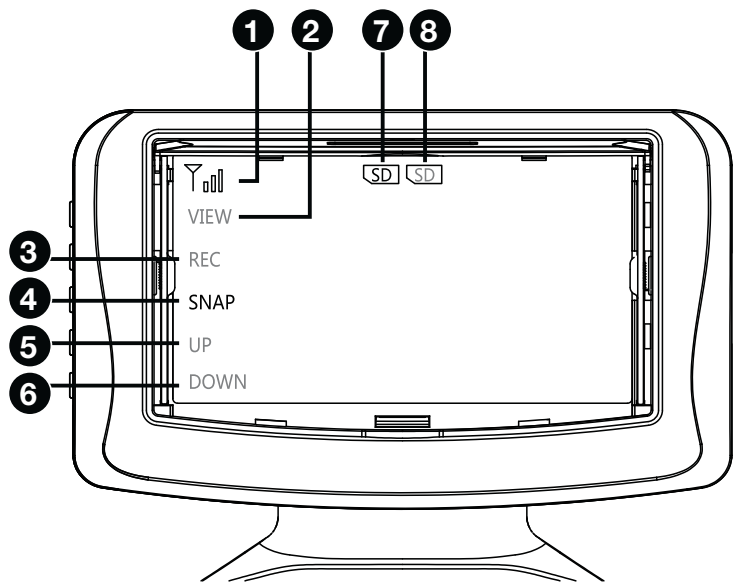

\*Fig 2.2.4

### 3. SETTING UP YOUR ZERO-X RAPTURE<sup>HD</sup>

#### 3.1 CHARGING THE BATTERY

Fully unwind the included USB charging cable and plug the USB end into the included USB wall charger. Only use the USB charging cable and wall charger included with the Rapture<sup>HD</sup>. If you are unable to use the supplied wall charger, please ensure that the charger that you use is C Tick certified and has an output minimum of DC 5V/1A and maximum of DC 5V/2.1A. Chargers above or below this range can potentially damage the battery and charger. When connected to a charging source the LED light in the charger will glow green. Connect the drone battery to the charging cable and the light will glow red indicating charging is in process. The LED on the USB charging cable will begin to glow green again once charging is complete. To keep the battery life as long as possible avoid removing the battery from the charging cable before charging is complete. If you have just finished flying your Rapture<sup>HD</sup>, please allow the battery to cool down for at least 30 minutes before recharging.

- If the battery is being charged by computer, make sure to pull out the USB cable if you want to shut down the computer.
- When connecting the USB cable with the battery, make sure to follow the correct polar indicator.
- When Flying the Rapture<sup>HD</sup>, low battery will be indicated when the remote control starts beeping and the lights on the Rapture<sup>HD</sup> start flashing.

### 3.2 INSTALLING THE RAPTURE<sup>HD</sup> BATTERY

- Ensure that the Rapture<sup>HD</sup>'s power switch is in the OFF position. (Refer to Fig 2.2.2 on page 8 - number 5)
- Connect the battery cable to the Rapture<sup>HD</sup>'s power cable ensure that the plug is inserted in the correct orientation.
- Tuck the cable into the battery opening.
- Insert the fully charged battery with the charging wires facing outwards.
- Connect the battery cable to the Rapture<sup>HD</sup>'s power cable. (Refer to Fig 3.2.1)
- Close the battery hatch making sure the door clicks into place. (Refer to Fig 3.2.2)

**FOR INFORMATION ON THE REMOTE CONTROL BATTERY, SEE SECTION MARKED REMOTE CONTROL**

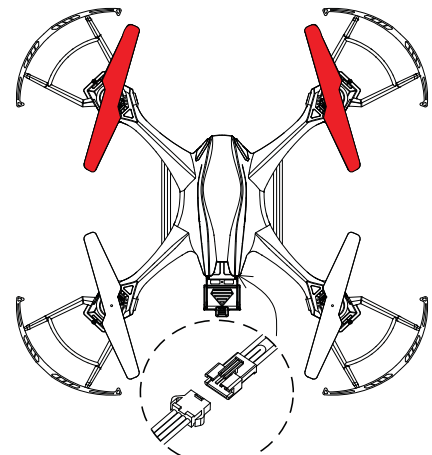

\*Fig 3.2.1

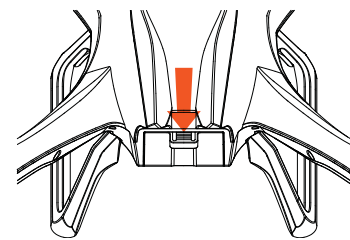

\*Fig 3.2.2

### 3.3 CAMERA CONNECTION GUIDE

- The camera on the Rapture<sup>HD</sup> should already be connected. It is advised that the camera is not removed and reconnected as this can potentially damage the camera connection.
- If it is necessary to plug these cables in make sure that the plugs are facing the correct way as plugging these in incorrectly could permanently damage the connection pins on the Rapture<sup>HD</sup>.

### 3.4 INSTALLING A MICRO SD CARD

- With the Rapture<sup>HD</sup> upside down and facing away from you insert the Micro SD Card into the side of the camera ensuring that the text side of the Micro SD Card is facing up. (Refer to Fig 3.4.1)
- Gently press the card in until you hear the lock click into place. (Micro SD Card not included)

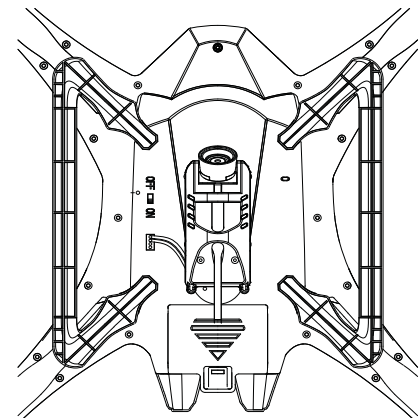

\*Fig 3.4.1

### 3.5 INSTALLING/REMOVING ROTOR GUARDS

- Rotor Guards are an optional fitting on the Rapture<sup>HD</sup>, however for safety reasons we strongly advise you to attach them. Whether Rotor Guards are attached or not, please be very careful when handling the drone. To avoid injury, do not touch the drone while the blades are turning or the remote control is powered on.

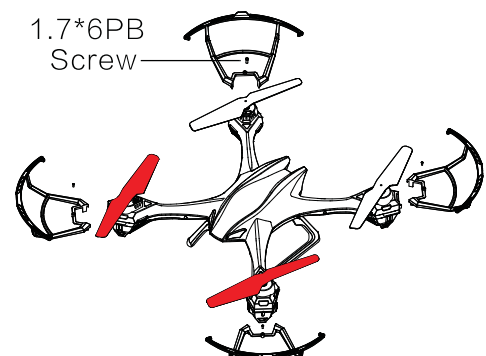

\*Fig 3.5.1

- Line up the guide pegs on the Rotor Guards with the holes on the arms of the Rapture<sup>HD</sup> so that the screw in the Rotor Guard matches up with the screw hole in the Rapture<sup>HD</sup>. (Refer to Fig 3.5.1)
- Firmly press the Rotor guard into position inserting one peg at a time.
- Insert the included screws into the screw holes and use the included screwdriver to tighten the screws making sure not to over tighten.

### 3.6 REMOTE CONTROL

- Connect the Remote Control Battery to the included Remote Control Battery Charging Cable and connect the USB end into the included USB wall charger. (Refer to Fig 3.6.1)

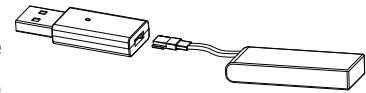

\*Fig 3.6.1

- The red light on the Remote Control Battery Charger will turn off once the battery is fully charged, once charged disconnect the battery from the charger.
- Ensure that the Remote Controls' power switch is in the OFF (Left) position.
- With the included screwdriver unscrew the battery cover on the rear of the Remote Control.

- Remove the Battery Cover.

- Connect the Battery cable to the power cable inside the Remote Control battery hatch. (Refer to Fig 3.6.2)

- Insert the Remote Control battery into the battery slot and make sure that the wires are tucked in to ensure they are not crushed by the battery cover.

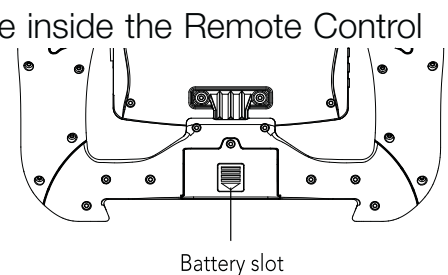

Battery slot

\*Fig 3.6.2

- Replace the battery cover making sure not to over tighten the screw.

## 4. FLIGHT SAFETY

Before flying your Rapture<sup>HD</sup> make sure that you are in a safe setting. CASA restrictions regarding flying drones require the drone be no closer than 5.5kms from any airport or airfield whilst flying. Drones should also not be flown over populated areas or any closer than 30 metres from vehicles people or animals.

It is also required that you check your surroundings before taking off making sure there are no obstacles or dangers in the area, including overhead power lines and bodies of water. If there are hazards present in your intended area of flight, please consider an alternative location.

### 4.1 FLYING YOUR RAPTURE<sup>HD</sup>

1. After installing a fully charged battery into the Rapture<sup>HD</sup> and Remote Control and conducting a complete check of your surroundings, turn the Power Switch (Refer to Fig 2.2.2 on page 8 - number 5) on the Rapture<sup>HD</sup> to the ON position.
2. Once the Rapture<sup>HD</sup> is powered on, the LED lights on the arms should flash, signalling no connection to the Remote Control. Place the Rapture<sup>HD</sup> on flat ground facing away from you and move back three meters.

3. With the Left Thumbstick (Acceleration/Yaw) (Refer to Fig 2.2.3 on page 8 - number 2) in the lowest (down) position, power on the Remote Control, the remote should beep once to indicate power up has been successful.
4. To activate the connection between the Remote Control and the Rapture<sup>HD</sup>, move the Left Thumbstick (Acceleration/Yaw) (Refer to Fig 2.2.3 on page 8 - number 2) on the Remote Control to the highest (up) position, hold for one second and then return the Left Thumbstick (Acceleration/Yaw) to the lowest (down) position holding for another 5 seconds. (Refer to Fig 4.1.1) The remote should beep three times, the lights on the arms of the Rapture<sup>HD</sup> should shine solid and the power indicator light on the Remote Control will shine solid indicating that the connection has been successful.
5. Calibrate the Rapture<sup>HD</sup> by holding the Right Thumbstick (Pitch/Roll) (Refer to Fig 2.2.3 on page 8 - number 3) in the bottom right position. This ensures that the Rapture<sup>HD</sup> stays level and flies straight. The Lights on the Rapture<sup>HD</sup> will flash fast while calibrating. Keep holding the Thumbstick in the bottom right position until calibration is complete.

HOLD Left Thumbstick UP for 5 seconds

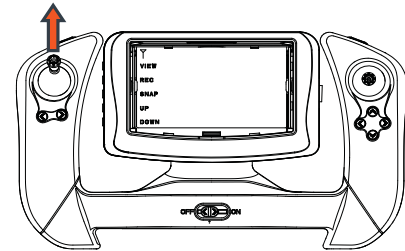

HOLD Left Thumbstick DOWN for 5 seconds

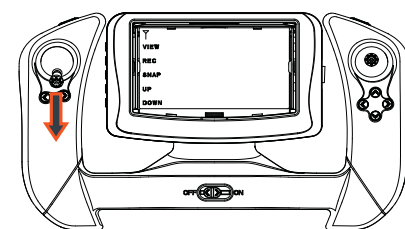

\*Fig 4.1.1

If the Rapture<sup>HD</sup> starts to fly abnormally, it may need to be re-calibrated. To recalibrate the Rapture<sup>HD</sup> turn the Remote Control and Rapture<sup>HD</sup> off, and then restart the Launching your Rapture<sup>HD</sup> process.

## 4.2 TROUBLE SHOOTING

Once activated do not approach the drone again until the remote has been powered off. If for any reason the Rapture<sup>HD</sup> does not work after following the launching steps, please check the following:

- a) The Rapture<sup>HD</sup> batteries are fully charged, correctly connected and not damaged.
- b) The connection between the Remote Control and the Rapture<sup>HD</sup> may not have been completed correctly. Ensure that when activating the connection, the Left Thumbstick is moved all the way to the top and then all the way to the bottom. If this is not completed the connection will not activate.

**Once these elements have been checked turn both the Rapture<sup>HD</sup> and the Remote Control off and start the launching process again.**

## 4.3 CONTROLLING YOUR RAPTURE<sup>HD</sup>

### BASIC CONTROLS

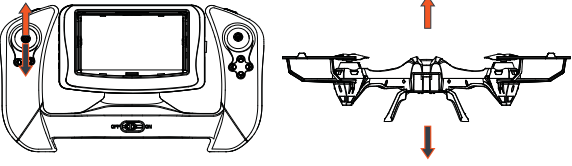
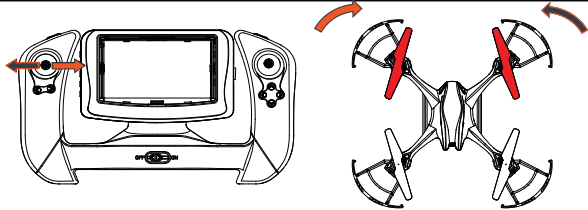
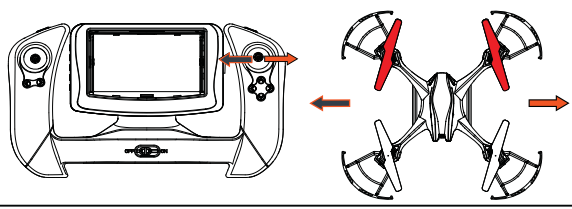
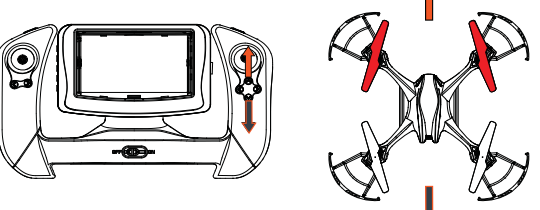
<b>Lift / Descent</b>	
	<p>Push up the Throttle Rudder Stick and the drone will fly up. Push down the Throttle Rudder Stick and the drone will fly down.</p>
<b>Yaw Left / Right</b>	
	<p>Push the Left Rudder Stick to the left or to the right, the drone will rotate in the corresponding direction.</p>
<b>Roll Left / Right</b>	
	<p>Push the Right Stick to the left or to the right, the drone will fly in the corresponding direction.</p>
<b>Pitch Forward / Back</b>	
	<p>Push the Right Stick forward or backward, the drone will fly in the corresponding direction.</p>

\*Fig 4.3.1

## 4.4 SPEED MODES

The Rapture<sup>HD</sup> has 3 speed modes that control the acceleration and manoeuvrability of the drone.

To cycle through the Speed Modes, use the Speed Button (*Refer to Fig 2.2.3 on page 8 - number 14*) on the rear of the left handle of the Remote Control.

### LOW

When the Rapture<sup>HD</sup> is powered up it will start in LOW speed mode.

In this mode the Rapture<sup>HD</sup> will control and fly slowly. It is advised that beginners use this mode to learn the basics before moving onto the two higher modes

## MID

Push the Speed Button (Refer to Fig 2.2.3 on page 8 - number 14) once and the Remote Control will quickly beep twice indicating that the Rapture<sup>HD</sup> is now in the medium Speed Mode.

In this mode the sensitivity of both the acceleration, and directional control of the Rapture<sup>HD</sup> will be increased, making the Rapture<sup>HD</sup> more nimble and quick.

## HIGH

Pushing the Speed Button (Refer to Fig 2.2.3 on page 8 - number 14) the Remote Control will quickly beep twice indicating that the Rapture<sup>HD</sup> is now in the High Speed Mode.

In this mode the sensitivity of both the acceleration and directional control will be increased again. It is advised that this mode is only used in a very open space once the pilot has gained significant drone flight experience.

Push the Speed button again to return the drone to Low Speed setting.

## 4.5 TRIMMING

Trimming is used to balance the Rapture<sup>HD</sup> when the flight is off centred. Please check before attempting to use trimming that the Rapture<sup>HD</sup>'s flight is not being affected by outside forces such as wind.

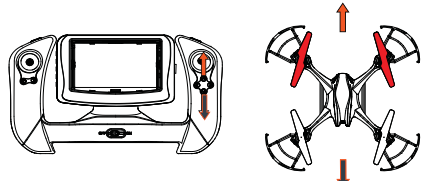
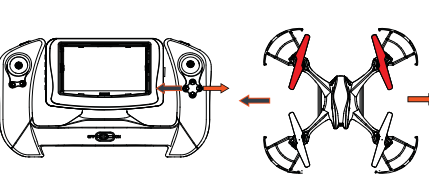
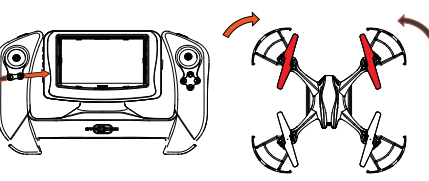
Trimming Pitch	
	To trim the Rapture <sup>HD</sup> s' pitch, use the Pitch Trim Controls (Refer to Fig 2.2.3 on page 8 - number 5) which are the top and bottom buttons below the Right Thumbstick. This will balance the forward and back movement of the Rapture <sup>HD</sup> .
Trimming Roll	
	To trim the Rapture <sup>HD</sup> s' roll, use the Roll Trim Controls (Refer to Fig 2.2.3 on page 8 - number 5) which are the left and right buttons below the Right Thumbstick. This will balance the left and right movement of the Rapture <sup>HD</sup> .
Trimming Yaw	
	To trim the Rapture <sup>HD</sup> s' Yaw, use the Yaw Trim Controller (Refer to Fig 2.2.3 on page 8 - number 4) which is the small switch on the Remote Control below the Left Thumbstick. This will balance the left and right spin of the Rapture <sup>HD</sup> .

\*Fig 4.5.1

## 4.6 360° FLIPPING

The Rapture<sup>HD</sup> is capable of performing 360° flips. This is possible by using the Flip button (Refer to Fig 2.2.3 on page 8 - number 15).

To Perform a forward flip push the Flip Button (Refer to Fig 2.2.3 on page 8 - number 15) on the back side of the Remote Controls Right handle. This will launch the Rapture<sup>HD</sup> forward into a forward flip.

Please ensure that you have a 2 metre clearance below, and in all directions around the drone before attempting to flip as this manoeuvre requires considerable space. Flips will be deactivated when the Rapture<sup>HD</sup> has low power, and will be reactivated once the battery is charged.

## 4.7 USING YOUR CAMERA

The camera on the Rapture<sup>HD</sup> is controlled via the Record and Snap buttons on the left hand side on the FPV screen.

When you are intending to use the camera, please ensure that you have inserted a Micro SD Card (Micro SD Card not included) into the Micro SD Card slot in the camera on the underside of the Rapture<sup>HD</sup>. The camera will not record to a SD Micro card that is inserted into the FPV screen.

The Left SD icon on the FPV screen will display green when a Micro SD Card is detected, and it is ready to record video or take still photos.

If the SD icon does not display green, or shows “ERR”, try re inserting the Micro SD Card into the Rapture<sup>HDs</sup>’ Camera and restart the Rapture<sup>HD</sup>. If this issue persists please ensure you are using a compatible Micro SD card.

### SHOOTING VIDEO:

The Rapture<sup>HD</sup> will capture 60 second clips, once it has finished recording a clip it will begin a new clip and continue recording 60 second clips until you stop recording. (Refer to Fig 4.7.1)

To start recording video, push the Record button (Refer to Fig 2.2.3 on page 7 - number 8) on the left side of the FPV Screen. The FPV screen will flash the word “REC” in red at the top of the screen and a counter will show timing the clip length indicating that recording is in progress. To stop recording push the Record Button again. Ensure you have stopped recording before removing the Micro SD Card, or turning the power off on your Rapture<sup>HD</sup>. (Refer to Fig 4.7.1)

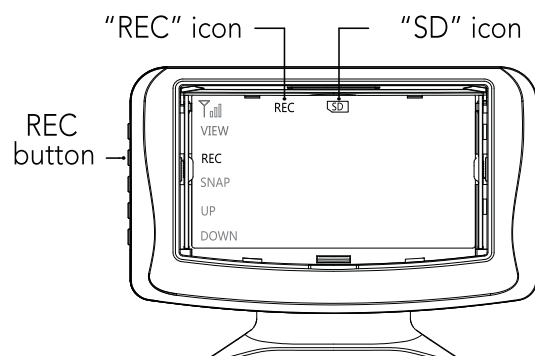

\*Fig 4.7.1

## SHOOTING PHOTOS:

To shoot a photo with your Rapture<sup>HD</sup> press the Snap button (Refer to Fig 4.7.2) on the left side of the FPV screen. "JPG" will be displayed at the top of the FPV screen in red indicating that a photo has been taken.

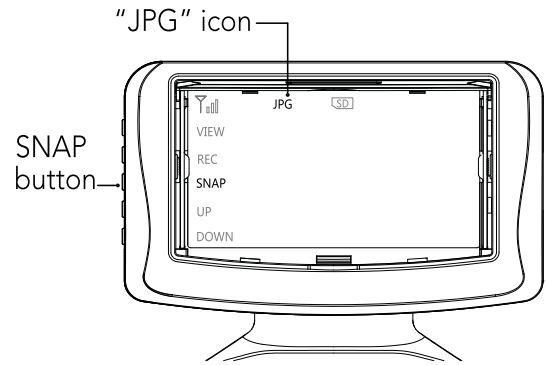

\*Fig 4.7.2

## 4.8 FIRST PERSON VIEW DISPLAY

When connected the First Person Display streams the video from the Rapture<sup>HD</sup>s camera as well as gives the ability to play back footage from an inserted SD Micro Card.

### INTERFACE

The FPV interface can be controlled using the five buttons on the side of the FPV screen. (Refer to Fig 4.8.1)

In the front menu the buttons control recording footage, taking photos, viewing recorded Videos/Photos and adjusting the brightness of the FPV screen.

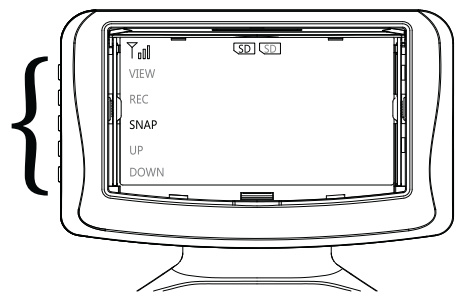

\*Fig 4.8.1

### BRIGHTNESS

To increase or decrease the brightness of the FPV screen use the up and down buttons on the front menu. (Refer to Fig 4.8.2)

### PAIRING

If you are in an area where more than one drone is being flown it is recommended that you pair your FPV screen to your drone to avoid signal interference.

UP Button (brighter)  
DOWN Button (darker)

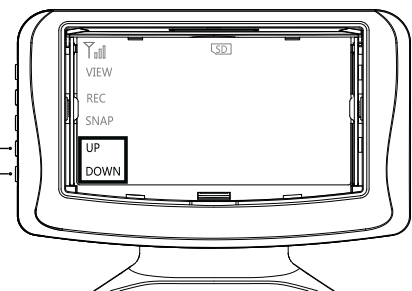

\*Fig 4.8.2

To pair your FPV screen to your Rapture<sup>HD</sup>:

1. Connect your Rapture<sup>HD</sup> to the controller by following the connection instructions in the section named 'Flying your Rapture<sup>HD</sup>'.
2. Once paired hold the Up button in the Front Menu for six seconds, this will then allow you to pair the Rapture<sup>HD</sup> to the FPV Screen by pushing the Up button again.
3. The FPV screen will then take five seconds to bind the connection which will be counted down on screen.
4. The FPV Screen and Rapture<sup>HD</sup> are now paired.



## DIRECTORY SCREEN

The Directory Screen is used to playback and delete Videos and Photos.

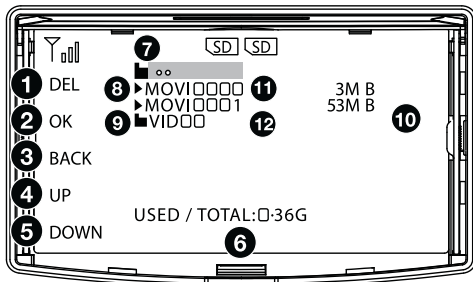

\*Fig 4.8.3

1. Delete (View Button)	7. Back Navigation
2. OK / Select (Record Button)	8. Playable File
3. Back (Photo Button)	9. Folder
4. Up Button	10. File Size
5. Down Button	11. File Name
6. Micro SD Card Capacity / Used	12. Folder Name

## VIEWING

The FPV screen will allow you to view Videos and Photos taken with the Rapture<sup>HD</sup>.

To view recorded Video or photos, remove the Micro SD Card from the Rapture<sup>HD</sup> camera, and insert into the FPV Screen Micro SD Card Slot. (Refer to Fig 2.2.2 & Fig 2.2.3 on page 8)

**PLEASE NOTE. THE FPV SCREEN CANNOT REMOTELY PLAY VIDEOS / PHOTOS FROM A MICRO SD CARD THAT IS IN THE RAPTURE<sup>HD</sup>'S CAMERA.**

Once inserted, a white SD icon will appear at the top of the Front Menu indicating that a Micro SD card has been detected. If the SD icon does not appear, or shows "ERR", try re-inserting the Micro SD Card into the FPV Screen and restarting the Remote Control. If this issue persists ensure you are using a compatible Micro SD card.

Press the View Button (Refer to Fig 2.2.3 on page 8 - number 7) on the FPV screen which will take you to the directory screen. In this screen the Up (10) and Down (11) buttons are used to navigate the folders, the Snap Photo Button (8) is used to navigate back and the Record Video Button (9) is used to select. (Refer to Fig 2.2.3 on page 8 - numbers listed above)

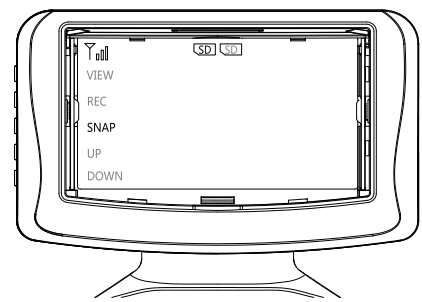

\*Fig 4.8.4

To view a video or photo use the navigational buttons to access folders and select (Refer to Fig 2.2.4 on page 9) a video or photo. Once a video has completed playing the next video in the folder will be queued to play. This will continue until playback is stopped or the last file in a folder is played.

## DELETING VIDEOS AND PHOTOS

With the delete function you can delete videos and photos taken with the Rapture<sup>HD</sup>.

To delete a file from a Micro SD Card select the file that is required to be deleted and push the Delete button (View). (Refer to Fig 2.2.3 on page 8 - number 7). You will then be asked if you are sure you want to delete this file, select Yes or No accordingly and push OK (Refer to Fig 2.2.3 on page 8 - number 8) to proceed.

## 5. MAINTENANCE

### 5.1 CLEANING:

Avoid exposing your Rapture<sup>HD</sup> and it's accessories to dust, sand and moisture as these can damage the Rapture<sup>HD</sup>. If the Rapture<sup>HD</sup> is exposed to dust or sand, use a soft brush to remove any visible particles.

### 5.2 ROTOR BLADE REPLACEMENT:

1. Use the Included screwdriver to remove the screw on the base of the Rotor Blade.
2. Gently remove the Rotor Blade.
3. Ensure that you are replacing the Rotor Blade with the correct blade as there are two different orientations of blades which are labelled A and B.

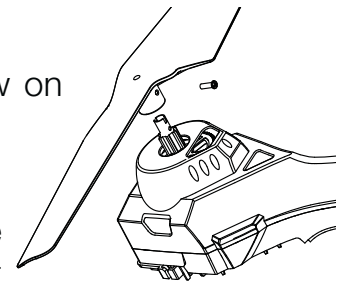

\*Fig 5.1.1

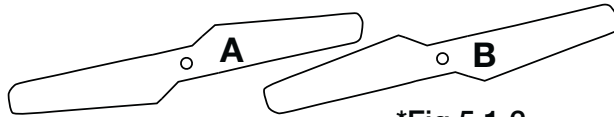

\*Fig 5.1.2

**IF THE INCORRECT BLADE IS USED IN THE INCORRECT PLACEMENT THE RAPTURE<sup>HD</sup> WILL NOT WORK.**

Different colour Rotor Blades are used so it is easy to identify the front and rear of the Rapture<sup>HD</sup> when flying. To ensure that it is easy to fly the Rapture<sup>HD</sup> make sure that the front and rear blades are different colours. (Refer to Fig 5.1.3)

4. Gently push the replacement Rotor Blade onto the rod ensuring that the screw hole on the Rotor hole lines up with the hole on the rod.

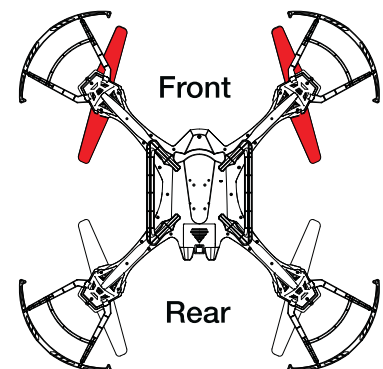

\*Fig 5.1.3

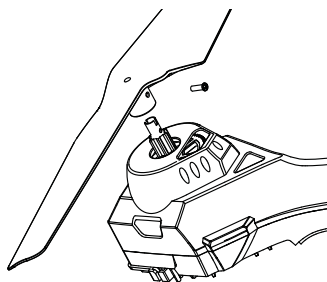

\*Fig 5.1.4

Replace the screw, being careful not to over tighten. If the screw will not fit into place, remove the screw and make sure that the holes on both the Rotor Blade and the rod are aligned.

### 5.3 MOTOR REPLACEMENT GUIDE

The Rapture<sup>HD</sup> uses brushed motors similar to what is used in remote control cars. These motors do need to be replaced from time to time to keep your drone up in the air.

The following instructions will take you through how to replace your motors when they are not working like new. It is recommended that before you attempt to replace the motors you set up a clean level space.

### 5.4 ROTOR BLADE REPLACEMENT:

1. Turn the Rapture<sup>HD</sup> upside down and remove the 3 screws in the motor housing and the screw in the LED window. (Refer to Fig 5.4.1)

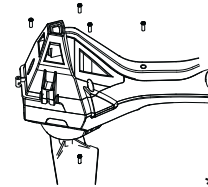

\*Fig 5.4.1

2. Carefully remove the motor housing panel and the LED window. (Refer to Fig 5.4.2)

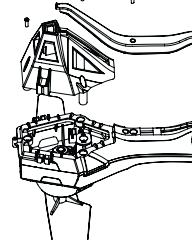

\*Fig 5.4.2

3. Turn the Rapture<sup>HD</sup> right side up and remove the two screws from the motor. (Refer to Fig 5.4.3)

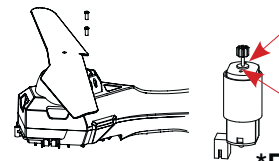

\*Fig 5.4.3

4. Remove the motor from the bottom of the motor housing. (Refer to Fig 5.4.4)

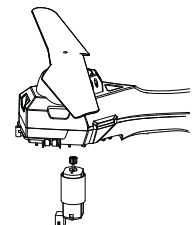

\*Fig 5.4.4

5. Remove the adhesive from the motor's power plug using a blunt flat instrument to scrape back the adhesive. (Refer to Fig 5.4.5)



\*Fig 5.4.5

6. Unplug the motor's power plug being careful not to pull the socket off the circuit board.
7. Remove the heat sink from the old motor and slip it over the new motor being careful not to block the new motor's ventilation hole.

8. Connect orientation (clockwise, counter clockwise). Clockwise motors will have a red connector socket and will be marked with the code "CW", while counter clockwise motors will have a white connector socket and will be marked with the code "CCW". (Refer to Fig 5.4.6)

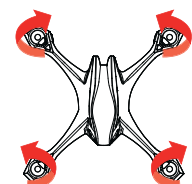

\*Fig 5.4.6

9. Slip the motor back into the motor housing making sure that the screw holes in the top of the motor align with the screw holes in the motor housing and the teeth on the gears synchronise. (Refer to Fig 5.4.7)

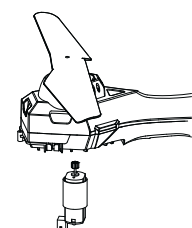

\*Fig 5.4.7

10. Replace the screws in the top of the motor securing the motor to the motor housing (it is recommended that you use a magnetic screwdriver as the motors also contain magnets and can make it difficult to insert these screws). (Refer to Fig 5.4.8)

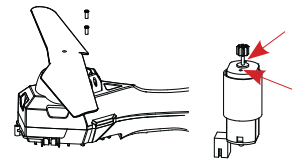

\*Fig 5.4.8

11. With the motor re attached put the LED window, and motor housing panel back in place and re attach the screws making sure not to over tighten. (Refer to Fig 5.4.9)

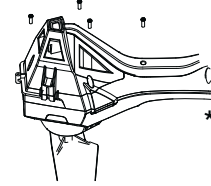

\*Fig 5.4.9

## 6. PARTS AND ACCESSORIES

To purchase parts and accessories for your Zero-X Rapture<sup>HD</sup>, please visit your nearest Zero-X retailer or visit us online at [www.zero-x.com.au](http://www.zero-x.com.au)

**ZXRBSRBW** Rotor Blades: Rapture, Rapture<sup>HD</sup> & Spectre drones – Black and White

**ZXRBSRBO** Rotor Blades: Rapture, Rapture<sup>HD</sup> & Spectre drones – Black and Orange

**ZXRBSRBR** Rotor Blades: Rapture, Rapture<sup>HD</sup> & Spectre drones – Black and Red

**ZXRBSRVP** Rotor Blades: Rapture, Rapture<sup>HD</sup> & Spectre drones – Value Pack

**ZXBATSR1K** 1000mAh Battery for Rapture, Rapture<sup>HD</sup> and Spectre drones

**ZXCHSRDR** Battery charger for Rapture, Rapture<sup>HD</sup> & Spectre drones

**ZXBATSRCT** Battery and charger for the Rapture & Rapture<sup>HD</sup> remote control

## 7. SPECIFICATIONS

Dimensions	48cm x 48cm x12cm
Weight	320g
Channels	4
Battery	1000mAh
Motors	4
Transmitter Battery	350mAh Rechargeable
Screen	Colour FPV screen
Frequency	2.4
Camera Resolution	720P
Photo Resolution	2MP
Video Format	AVI
Photo Format	JPG
Memory	Micro SD Card (up to 32GB)
Battery	5V, 2A, USB

## 8. WARRANTY TERMS & CONDITIONS

Our goods come with guarantees that cannot be excluded under the Australian and New Zealand Consumer Law. You are entitled to a replacement or refund for a major failure and for compensation for any other reasonably foreseeable loss or damage. You are also entitled to have the goods repaired or replaced if the goods fail to be of acceptable quality and the failure does not amount to a major failure.

This warranty is provided in addition to your rights under the Australian & New Zealand Consumer Law.

Zero-X warrants that this product is free from defects in material and workmanship for a period of 12 months from the date of purchase or for the period stated on the packaging. This warranty is only valid where you have used the product in accordance with any recommendations or instructions provided by Zero-X.

This warranty excludes defects resulting from alterations of the product, accident, misuse, abuse or neglect.

In order to claim the warranty, you must return the product to the retailer from which it was purchased or if that retailer is part of a National network, a store within that chain, along with satisfactory proof of purchase. The retailer will then return the goods to Zero-X. Zero-X will repair, replace or refurbish the product at its discretion. The retailer will contact you when the product is ready for collection. All costs involved in claiming this warranty, including the cost of the retailer sending the product to Zero-X, will be borne by you.

### **Zero-X Address:**

33 Quinn Drive, Keilor Park

Victoria 3042 Australia

**Ph:** +61 03 8331 4800

**Email:** [service@zero-x.com.au](mailto:service@zero-x.com.au)

This page was intentionally left blank

This page was intentionally left blank

**ZERO-X**<sup>®</sup>

[www.zero-x.com.au](http://www.zero-x.com.au)  
[www.zero-x.co.nz](http://www.zero-x.co.nz)



© Zero-X v1.0 2016